

X-VSR-SV1 Series User's Manual

Low vacuum vertical stages with built-in controllers



Disclaimer

Zaber's products are not intended for use in any critical medical, aviation, or military applications or situations where a product's use or failure could cause personal injury, death, or damage to property. Zaber disclaims any warranty of fitness for a particular purpose. The user of this product agrees to [Zaber's general terms and conditions of sale](#).

Precautions

Zaber's motion control devices are precision instruments and must be handled with care. In particular, moving parts must be treated with care. Avoid axial loads in excess of the rated thrust load, axial and radial impact, dust and other contaminants and damage to the drive components. These will reduce the performance of the device below stated specifications.

Do not touch vacuum devices with your bare hands. The oil from your skin can significantly increase the pump down time of your chamber. Always wear cleanroom gloves when handling high vacuum positioners and other high vacuum components.

Leave the device in its packaging until you are ready to put it into your vacuum chamber. Once the device has been removed from its packaging, make sure the device is stored and operated only in clean, dry environments.

Overheating Precautions

The lifetime of the motor and stage will be prolonged by keeping the operating temperatures as low as possible. The motor housing temperature of Zaber's vacuum devices should never exceed 80°C, as the longevity of the devices will be compromised.

Monitoring Temperature

There are a few ways to monitor temperature on Zaber devices:

- A and X Series devices have an integrated temperature sensor on their controllers. This may be polled in ASCII using the [get system.temperature](#) command. Please see the [protocol manual](#) for more details.
- A K-type thermocouple or other temperature sensor may be mounted to the stage to monitor temperature in order to reduce the risk of overheating. The thermocouple should be attached to the device's motor housing. An example of a proper mounting location is shown below.

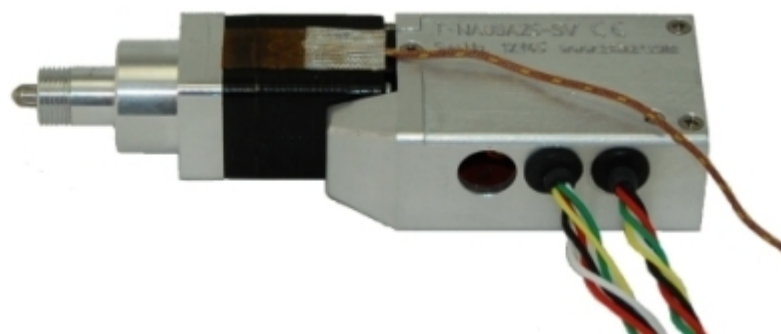

Duty Cycle and Run and Hold Currents

The default run currents on Zaber vacuum devices are typically set lower than their non-vacuum counterparts, however under high duty cycles they may have to be further lowered. Combining low run and hold currents with a reduced duty cycle will often prevent overheating in all but the most extreme of cases.

It is good practice to reduce the hold current as much as is practical for vacuum devices. Positioners with an A pitch lead screw often do not need a hold current at all to maintain their position. Reducing the hold current is an easy way to reduce the heat generated by your vacuum stage or actuator.

Please contact [Zaber Technical Support](#) to help select the optimal duty cycle and current settings for your positioner.

Vacuum Baking

Vacuum devices can be vacuum baked to reduce pump down time and outgassing. The procedure is to heat the device to its recommended bake-out temperature at a vacuum of less than 10^{-3} Torr for a period of several hours. Allowable bake-out temperature for Zaber's vacuum devices is 80°C.

Do not exceed these temperatures as there are polymer based components in the stage and electrical components in the controller that can be permanently damaged or have their lifetimes significantly shortened by overheating.

Conventions used throughout this document

- Fixed width type indicates communication to and from a device. The `\r` symbol indicates a carriage return, which can be achieved by pressing enter when using a terminal program.
- An [ASCII command](#) followed by (T:xx) indicates a legacy T-Series [Binary Protocol](#) command that achieves the same result. For example, `move abs 10000 (T:20:10000)` shows that a move abs ASCII command can also be achieved with Binary command number 20.

Not all ASCII commands have an equivalent Binary counterpart.

Quick Tutorial

We recommend using [Zaber Launcher](#) to communicate with the device(s). For other software options, see the [Software](#) page. Please refer to the [Protocol Manual](#) for more detailed information on the available commands.

Initial Set-up



ORDER OF CONNECTORS MAY VARY BETWEEN DEVICE SERIES

- Daisy chain all integrated devices and controllers together using the RS-232 "Prev" and "Next" connectors (see [Daisy-Chaining Devices](#) for more details).
- Next, supply power to one or more devices. Many products share power through the daisy-chain cables. The green power indicator on each should light up.
- Download and install [Zaber Launcher](#). Start Zaber Launcher.
- Create a New Connection and select the communications port the first controller is connected to. For instructions on how to find the available communication ports on your system, please refer to: [Appendix A - Available Communications Ports](#).
- If multiple devices are detected and there are conflicting device numbers, Zaber Launcher will renumber them or you can [renumber \(T:2\)](#) them as desired. The first device in the chain (closest to the computer) will become Device 1, the next will become Device 2, and so on.

Initialization

Every time the device is powered up or reset, you should return the positioner to the home position. This is achieved by sending the [home \(T:1\)](#) command to the individual device or all devices. Until this is done, most positioners will only allow motion in one direction, towards the sensor.

If it is not possible in your application to home the positioner after every power-up, see the [tools_parking \(T:65\)](#) command. Parking allows the device to be turned off and then used at a later time without first having to home the axes.

Using the Device

Several commonly used ASCII commands and their Binary equivalents are shown below. For a full list of available commands, please refer to the [Protocol Manual](#).

Command	Description
/1 1 get_pos (T:60)	Query the current position of Device #1 Axis #1.
/1 1 move_abs 10000 (T:20:10000)	Move Device #1, Axis #1 to position 10000 microsteps.
/2 1 move_rel -12800 (T:21:-12800)	Move Device #2, Axis #1 in the negative direction by 12800 microsteps.
/1 stop (T:23)	Decelerate and stop ALL axes on Device 1. An axis number of 0 or no axis number implies all axes on the device, or the device itself.
/ move_vel 153600 (T:22:153600)	Move ALL devices and ALL axes in the positive direction at the speed 153600. A device address of 0 or no device address implies all devices in the chain.

Modifying Device Settings

Here are some examples if you would like to customize particular device or axis settings. Refer to the [Protocol Manual](#) for detailed descriptions of each setting.

Command	Description
/1 set maxspeed 100000 (T:42:100000)	Set the speed of all axes on the device.
/1 get maxspeed (T:53:42)	Query the maximum speed of all axes on the device.
/1 system_restore (T:36)	Restore all the settings of Device 1 to the default.

Firmware Upgrades

To allow access to new features and bug fixes, this Zaber device can be upgraded remotely through the Firmware Upgrade app in Zaber Launcher. In the "My Connections" window, click on the "..." menu to the right of the device and select "Firmware Upgrade".

Device Overview

Connectors

All images are shown looking into the device.

RS-232 Communications

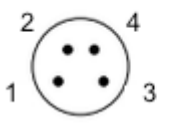
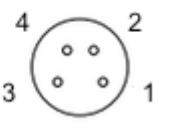
	RS-232 PREV	RS-232 NEXT	Pin	Previous	Next	Colour
			1	Power (max 4 A)	Power (max 4 A)	Brown
			2	Ground	Ground	White
			3	Receive	Transmit	Blue
			4	Transmit	Receive	Black

Default Settings

- Baud rate: 115200
- Protocol: Zaber ASCII

Specifications

- Supported Protocols: Zaber ASCII, Zaber Binary
- Supported baud rates: 9600, 19200, 38400, 57600, 115200
- Bits: 8
- Parity: None
- Stop Bits: 1
- Flow Control: None

Other Connectors

For any connections not described in this document, cables should be limited to a length of 3 m.

Indicators

Vacuum devices may have obstructed or hard to view LED indicators. If you can not locate the indicators, please contact [Zaber Technical Support](#).

Green (Device) - Power

- On: Controller is operational.
- Blinking twice per second: The power supply voltage or controller temperature is out of range.

Red (Device) - System Error

- On/blinking: An error has occurred. Please contact [Zaber Technical Support](#).

Yellow (Device) - Communication

- On: Data is being transferred.
- Blinking twice per second: Packet corruption has occurred for ASCII commands sent with a checksum.

Yellow (Axis) - Axis Status

- On: Axis is moving.

Blue (Axis) - Warning/Error

- Blinking twice per second: Driver is disabled due to over-temperature, out-of-range voltage or other driver fault; or due to user request. See [Fx Warning Flags](#). *Note: This may occur for a few seconds on power-up as device initializes.*
- Fading in and out slowly: The axis is parked. See the [tools parking \(T:65\)](#) command.

Installation

The X-VSR-SV can be connected to a computer as follows:

- Plug the M8 to USB adaptor ([X-USBDC](#)) into one of your computer's USB ports, then attach the device to the adaptor. You will want the first device in the chain to be the ([X-PIB](#)) so you can inject power outside of the vacuum chamber. You may need to use a cable extension to reach your computer. There is no need to power down or reboot the computer.
- Connect the power plug of your power supply to the power connector of the device. The green LED should light up indicating the device has power.
- Additional devices can simply be daisy-chained to the first. See [Daisy-Chaining Devices](#) below.
- Install software from the [Software](#) page. For the initial setup, using [Zaber Launcher](#) is recommended.



As a simple first test, try entering:

```
/renumber (T:2)
/1 home (T:1)
/1 move rel 10000 (T:21:10000)
```

The parameter of 10000 in the move command above specifies 10000 microsteps. To see the microstep size (default resolution) for the positioner and how it translates to displacement, first go to the [product overview](#) page, find your product, click through to the product's webpage, and click on the "Series Specs" tab. The microstep size (default resolution) will be shown in the list of product specs either in the "Group Specifications" section or the "Comparison" section.

Daisy-Chaining Devices

Multiple devices can be connected together in a chain through the Prev and Next connectors. This allows any number of devices to be controlled from a single connection to a computer, reducing cabling demands. In addition, X-Series devices carry power through the daisy chain, so in most cases a power supply only needs to be connected to one device in the chain. Whenever a device is added or removed from a chain, a [renumber \(T:2\)](#) command should be sent to prevent device address conflicts. If there are device address conflicts, Zaber Launcher will renumber automatically the next time you use it to connect to the chain.

Note: Daisy-chaining devices with cable lengths exceeding 8 m (25 ft) is not recommended.



Vacuum Device Mounting Considerations

If possible, vacuum positioners should be mounted to a thermally conductive surface to aid in heat dissipation. Preferably, there should be a conductive heat path from the positioner through to the outside of the chamber. If this is not possible, the device should be mounted to a large conductive surface within the chamber. This will help cooling by increasing the rate of radiative heat transfer.

Connecting Vacuum Devices to a Computer

Vacuum compatible devices have special requirements for their connection to a computer. Please read the instructions below carefully.

Power

No power connectors are provided on vacuum compatible devices. Instead, power must be supplied through the data cables. A special power injection box, the X-PIB, is required.



X-PIB Power Injection Box

Wiring/Feed-throughs

SV1 and SV2 vacuum devices are supplied with twisted 24 AWG signal wires and standard serial port connectors. The wires must be cut and connected (crimped, screwed, or soldered) to a vacuum feed-through before the device can be operated inside a vacuum chamber.

Two or three devices can be daisy chained inside a vacuum chamber, eliminating the need for extra feed-throughs. If this is to be done, it is recommended that the connectors be removed and the signal wires connected directly from one device to the next in the chain. The wire colours should be matched.

Trajectory Control and Behaviour

This section describes the behaviour of the axis trajectory when a movement command is issued.

Software Position Limits

The travel range of the axis is limited by the Minimum Position and Maximum Position settings. The factory settings for the axis are configured to match the physical travel range. If a customized range is desired, it can be changed by configuring the [limit.min \(T:106\)](#) and [limit.max \(T:44\)](#) settings to appropriate values. For the Current Position, query [pos \(T:60\)](#).

Minimum Position

When the Current Position is less than the Minimum Position value, the axis cannot move in the negative direction (towards the motor).

Maximum Position

When the Current Position is greater than the Maximum Position value, the axis cannot move in the positive direction (away from the motor).

Movement Speed

The movement speed of the axis depends on axis status and various speed settings. If the axis has not been initialized by the [home \(T:1\)](#) command or by moving towards the home end of the axis, movement speed will be constrained to fail-safe values. The home status of the axis can be determined by reading the [limit.home.triggered\(T:53:103\)](#) setting.

Movement speed of the axis is specified below:

[move vel \(T:22\)](#)

The axis will move at the specified speed regardless of home status.

Other movement commands - when the axis has not been homed

The axis will move at the slower of the [maxspeed \(T:42\)](#) and [limit.approach.maxspeed \(T:41\)](#) settings.

Other movement commands - when the axis has been homed

The axis will move at the speed specified by the [maxspeed \(T:42\)](#) setting.

Troubleshooting X-Series Motion Devices

The following sections contain tips for troubleshooting common problems.

Front Panel Indicators

Green LED on.

The device is powered on and is operating normally.

Green LED flashes slowly.

The operating conditions of the device are outside of the recommended range.

This will occur when the supply voltage is either over or under the recommended range or the controller temperature has exceeded the set limit. Check the following:

- The input voltage is within the operational range of the device. This can be read from the device with the [get system.voltage](#) command.
- The device temperature is within range. This can be read from the device with the [get system.temperature](#) command.

Green LED off.

The device is not powered.

Check the supply connections and power adaptor for correct operation.

Red LED on or flashing.

A critical error has occurred.

Please contact [Zaber Technical Support](#).

Yellow LED always off or flashes but no reply.

There are communication errors.

Please see the [Communication Errors](#) section below.

Blue (or Green for Firmware versions <7.15) LED Fades In and Out.

The axis is parked.

Issue a [tools parking unpark\(T:65:0\)](#) command, or [home \(T:1\)](#) the axis.

Blue LED blinking twice per second. Axis does not move.

Driver may be disabled due to over-temperature, out-of-range voltage or other driver fault; or due to user request.

See [Fx Warning Flags](#).

Once the issue has been resolved, send [driver enable](#).

Unexpected Behaviour

The axis doesn't respond to a move command.

The axis may need to be homed before use.

Send the [home \(T:1\)](#) command.

The axis is moving on its own and running against the ends of travel.

The position encoder has de-synchronized.

Reset the device by power cycling it or sending the [system reset \(T:0\)](#) command, then re-initialize it with the [home \(T:1\)](#) command.

The axis is moving very slowly. It used to move faster.

The speed settings may have been changed inadvertently.

Send a [system restore \(T:36\)](#) command.

The axis makes louder than normal noise during travel and is frequently slipping.

This condition happens if the thrust needed is more than the thrust available from the axis.

Check the following:

- The force on the axis is less than the maximum thrust.
- The voltage matches the specified voltage. Read the voltage using the [get system.voltage](#) command. Voltage less than the specified voltage for the device will reduce the positioner's maximum thrust.

Test the following:

- Try a slower target velocity. Stepper motors produce more thrust when moving slowly.
- Try a lower acceleration and deceleration.
- Clean the screw and lightly re-grease it with a grease that does not degrade plastics.

The axis has repeatability errors smaller than 4 full steps.

If steps aren't being skipped, friction or loose parts may still cause some variation when returning to a position.

Please contact [Zaber Technical Support](#).

The axis doesn't cover the full range of travel, or runs into the end.

A setting might have been inadvertently changed.

- [home \(T:1\)](#) the axis to see if this corrects the behaviour.
- Send a [system restore \(T:36\)](#) command.

The positioner's motor unexpectedly shuts off. An [Fx warning flag](#) is present.

The motor over-temperature protection switch has been tripped. This sensor will trip if the positioner's maximum continuous thrust specification is exceeded for too long. To prevent this condition from occurring again, reduce the average force that the motor outputs by reducing acceleration, reducing the load, or lowering the duty cycle.

Send a [driver enable](#) command. The axis does not require homing.

Communication Errors

There is no communication with the device; the Yellow LED does not come on or flash.

There are several things that should be checked:

- Make sure the correct serial port is selected. Try selecting other serial ports in the software.
- Check the baud rate, hand shaking, parity, stop bit, etc. when configuring the serial communications software. The required settings are listed in the [RS-232 Communications](#) section above.
- Make sure there are no bent pins in the ends of all the data cables
- Make sure the device is powered. The Green LED should be on.
- If the computer is a laptop running on batteries, try plugging in the power. Some laptops disable the serial ports when running on batteries.
- Make sure a null modem adaptor or cable is not being used.
- Make sure the correct adaptors (if any) are being used. Refer to the pinouts in the [RS-232 Communications](#) section above.
- If the problem was encountered when trying to control the device with custom software, try using Zaber Launcher or Zaber Console (available from the Zaber website) to verify that the hardware is functioning properly.

Two or more devices both respond to commands sent to device 1.

Most devices are shipped with their device number set as 1. If you connect to the devices with Zaber Launcher, it will automatically renumber them if needed. If you aren't able to install and open Zaber Launcher, send the [renumber \(T:2\)](#) command in the software you are using to set all of the device numbers to different values.

The Yellow LED comes on briefly when sending a command, but the axis does not move and does not reply.

Check baud rate, hand shaking, parity, stop bit, etc. are set as per the [RS-232 Communications](#) defaults.

The device numbers may not be what is expected, issue a [renumber \(T:2\)](#) command. Make sure that the computer does not transmit anything else while the devices renumber.

If using the Binary Protocol, check the following:

- 6 bytes are transmitted and that the device number and command are valid.
- The software does not transmit any control characters such as line feed and spaces.
- That the serial port is not configured with a termination character (it often defaults to linefeed).

If problems are encountered when using custom software, try using the Zaber Console (available from the Zaber website) to verify that the hardware works.

The device does not behave as expected when software sends it a series of commands.

If your computer's language and region settings are other than US English, your software may be sending non-ASCII characters or using commas instead of periods as decimal points. Try setting your computer's language to English and region to United States to see if it fixes the problem.

Check what is being sent out of the serial port. [stackoverflow.com](#) has a list of some tools to monitor serial ports.

In Binary mode, the device does not send replies but otherwise works.

Auto-reply might have been disabled via [T:101](#).

Send a [system restore \(T:36\)](#) command.

If the problem is encountered when trying to control the device with custom software:

- Use Zaber Console to verify that the hardware is functioning properly.
- Make sure that the receiving part of the code or commercial package is correct.
- Check the serial port settings are correct.
- Check connectors for bent or broken pins.

In Binary mode, the device sometimes returns fewer than 6 bytes.

This typically indicates a problem with the serial port settings. Some serial ports are set to automatically recognize and remove specific control characters such as carriage returns when they appear in the RS-232 receive buffer.

Check that the settings are correct and are not removing or replacing characters.

Slipping and Stalling

The axis makes noise but does not move.

The axis is stalling.

Try removing all external loads. If the axis now extends and retracts normally, the problem is excessive load. Try to reduce the load and ensure the load is less than the maximum thrust. A higher thrust or torque can be achieved by lowering the speed of the axis using the [maxspeed \(T:42\)](#) setting.

If an axis is stalling with no external load at default speed and acceleration settings then it requires servicing.

Warranty and Repair

For Zaber's policies on warranty and repair, please refer to the [Ordering Policies](#).

Standard products

Standard products are any part numbers that do not contain the suffix ENG followed by a 4 digit number. Most, but not all, standard products are listed for sale on our website. All standard Zaber products are backed by a one-month satisfaction guarantee. If you are not satisfied with your purchase, we will refund your payment minus any shipping charges. Goods must be in brand new saleable condition with no marks. Zaber products are guaranteed for one year. During this period Zaber will repair any products with faults due to manufacturing defects, free of charge.

Custom products

Custom products are any part numbers containing the suffix ENG followed by a 4 digit number. Each of these products has been designed for a custom application for a particular customer. Custom products are guaranteed for one year, unless explicitly stated otherwise. During this period Zaber will repair any products with faults due to manufacturing defects, free of charge.

How to return products

Customers with devices in need of return or repair should contact Zaber to obtain an RMA form which must be filled out and sent back to us to receive an RMA number. The RMA form contains instructions for packing and returning the device. The specified RMA number must be included on the shipment to ensure timely processing.

Email Updates

If you would like to receive our periodic email newsletter including product updates and promotions.

Contact Information

Contact Zaber Technologies Inc by any of the following methods:

Phone	1-604-569-3780 (direct) 1-888-276-8033 (toll free in North America)
Fax	1-604-648-8033
Mail	#2 - 605 West Kent Ave. N., Vancouver, British Columbia, Canada, V6P 6T7
Web	www.zaber.com
Email	Please visit our website for up to date email contact information.

The original instructions for this product are available at <https://www.zaber.com/manuals/X-VSR-SV1>.

Appendix A - Available Communications Ports

The following instructions outline how to find installed serial ports on your computer.

Windows

- Open Search or Run from the Start Menu or Taskbar, type "Device Manager" and press enter.

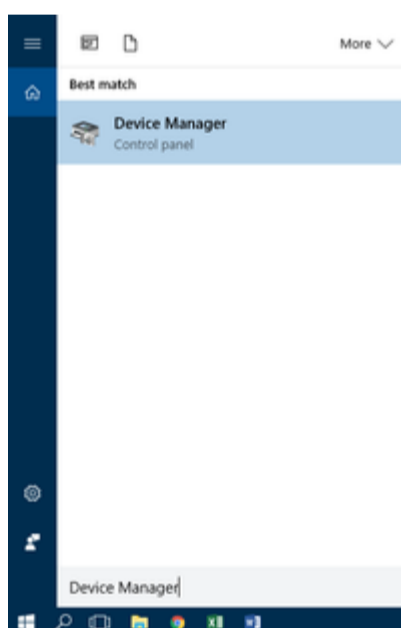

- Expand the Ports (COM & LPT) category.

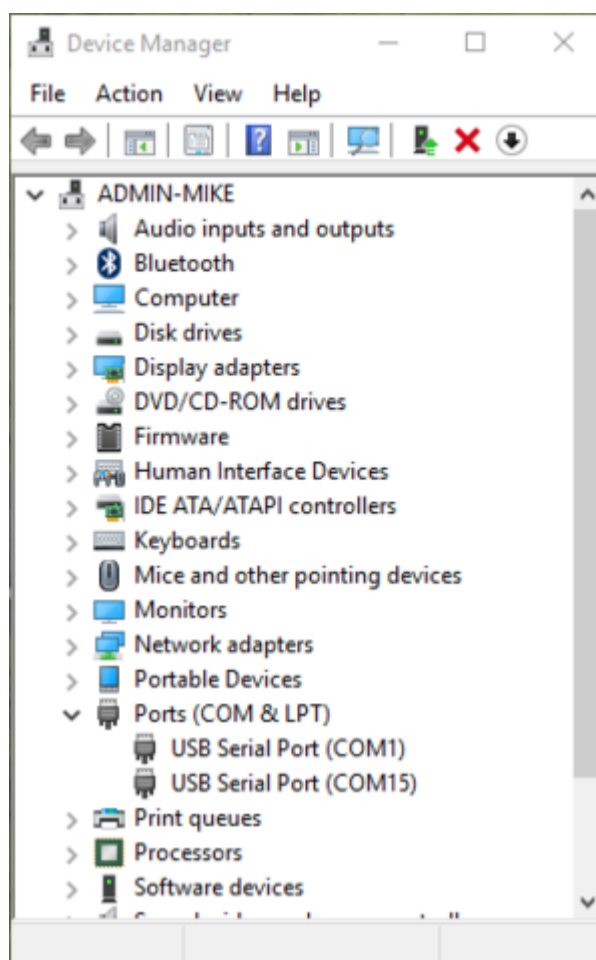

- In this example there are two serial ports available (COM1 and COM15), which are both USB adaptors.

Linux

- Finding devices

- Open a terminal and execute the following command:

```
dmesg | grep -E ttyU\?S
```

- The response will be similar to the following:

```
[ 2.029214] serial8250: ttyS0 at I/O 0x3f8 (irq = 4) is a 16550A
[ 2.432572] 00:07: ttyS0 at I/O 0x3f8 (irq = 4) is a 16550A
[ 2.468149] 0000:00:03.3: ttyS4 at I/O 0xec98 (irq = 17) is a 16550A
[ 13.514432] usb 7-2: FTDI USB Serial Device converter now attached to ttyUSB0
```

- This shows that there are 3 serial ports available: ttyS0, ttyS4 and ttyUSB0 (a USB adaptor)

- Checking port permissions

- Using the ports found above, execute the following command

```
ls -l /dev/tty{S0, S4, USB0}
```

- The permissions, given below, show that a user has to be root or a member of the dialout group to be able to access these devices

```
crw-rw---- 1 root dialout 4, 64 Oct 31 06:44 /dev/ttyS0
crw-rw---- 1 root dialout 4, 68 Oct 31 06:45 /dev/ttyS4
crw-rw---- 1 root dialout 188, 0 Oct 31 07:58 /dev/ttyUSB0
```

- Checking group membership

```
groups
```

- The output will be similar to the following:

```
adm cdrom sudo dip plugdev users lpadmin sambashare
```

Notice that dialout is not in the list

- A user can be added to the dialout group with the following command

```
sudo adduser $USER dialout
```

- Group membership will not take effect until the next logon.

OSX

- Finding devices

- Open a terminal and execute the following command:

```
ls /dev/cu.*serial*
```

- The response will be similar to the following:

```
/dev/cu.usbserial-FTB3QAET
/dev/cu.usbserial-FTEJJ1YW
```

- This shows that there are two serial ports available, both of which happen to be USB adaptors.

- There may be other devices that match this query, such as keyboards or some web cameras. To determine which one corresponds to your USB serial cable, try repeating the command with and without the cable connected to the computer, to see which one appears and

disappears.

Product Drawing

ZABER

X-VSR-SV Vacuum Compatible Vertical Lift Stage
dimensions in mm

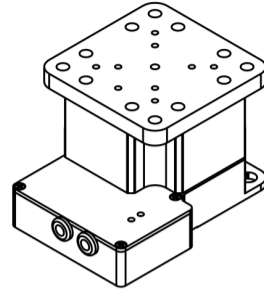

Model Number*	Travel	A	B	C
X-VSR20-SV	20.0	36.0	55.0	75.0
X-VSR40-SV	40.0	66.0	85.0	125.0

*See product page for complete list of available models at www.zaber.com

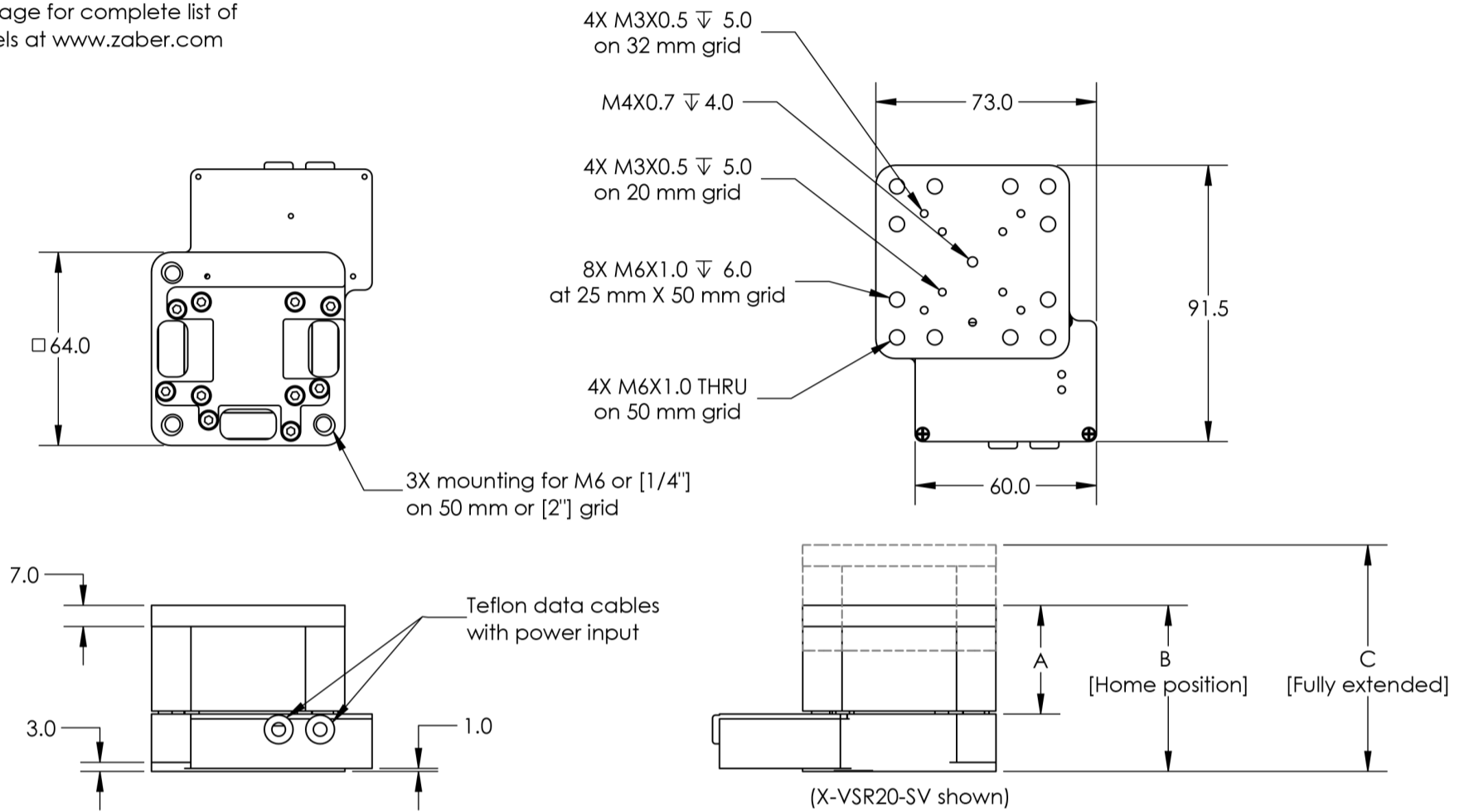

DWG 1758 R01

Specifications

Specification	Value	Alternate Unit
Microstep Size (Default Resolution)	0.09525 μm	
Built-in Controller	Yes	
Repeatability	< 1 μm	< 0.000039"
Loaded Backlash (10 N)	< 10 μm	< 0.000394"
Maximum Speed	28 mm/s	1.102"/s
Minimum Speed	0.000058 mm/s	0.000002"/s
Speed Resolution	0.000058 mm/s	0.000002"/s
Peak Thrust	200 N	44.9 lb
Maximum Continuous Thrust	100 N	22.4 lb
Communication Interface	RS-232	
Communication Protocol	Zaber ASCII (Default), Zaber Binary	
Data Cable Connection	Teflon flying leads with M8 4 pin M/F	
Maximum Centered Load	100 N	22.4 lb
Maximum Moment (Roll)	300 N·cm	424.8 oz·in
Maximum Moment (Pitch)	300 N·cm	424.8 oz·in
Maximum Moment (Yaw)	300 N·cm	424.8 oz·in

Specification	Value	Alternate Unit
Pitch	0.08°	1.396 mrad
Roll	0.08°	1.396 mrad
Yaw	0.08°	1.396 mrad
Power Supply	24-48 VDC	
Power Plug	None, use X-PIB	
Maximum Current Draw	950 mA	
Linear Motion Per Motor Rev	1.2192 mm	0.048"
Motor Steps Per Rev	200	
Motor Type	Stepper (2 phase)	
Motor Rated Current	700 mA/phase	
Inductance	8.7 mH/phase	
Default Resolution	1/64 of a step	
Mechanical Drive System	Precision Lead Screw	
Limit or Home Sensing	Magnetic home sensor	
Manual Control	No	
Axes of Motion	1	
Mounting Interface	M6 and M3 threaded holes	
Operating Temperature Range	0-50 °C	
RoHS Compliant	Yes	
CE Compliant	Yes	
Vacuum Compatible	Low vacuum (10 ⁻³ Torr)	

Comparison

Part Number	Travel Range	Accuracy (unidirectional)	Loaded Accuracy (10 N)	Backlash
X-VSR20A-SV1	20 mm (0.787")	50 µm (0.001968")	35 µm (0.001378")	< 35 µm (< 0.001378")
X-VSR40A-SV1	40 mm (1.575")	35 µm (0.001378")	20 µm (0.000787")	< 120 µm (< 0.004724")

Part Number	Guide Type	Horizontal Runout	Weight
X-VSR20A-SV1	Ball Bearing	< 30 µm (< 0.001181")	0.560 kg (1.235 lb)
X-VSR40A-SV1	Crossed-Roller Bearing	< 35 µm (< 0.001378")	0.770 kg (1.698 lb)

Charts and Notes

Thrust Speed

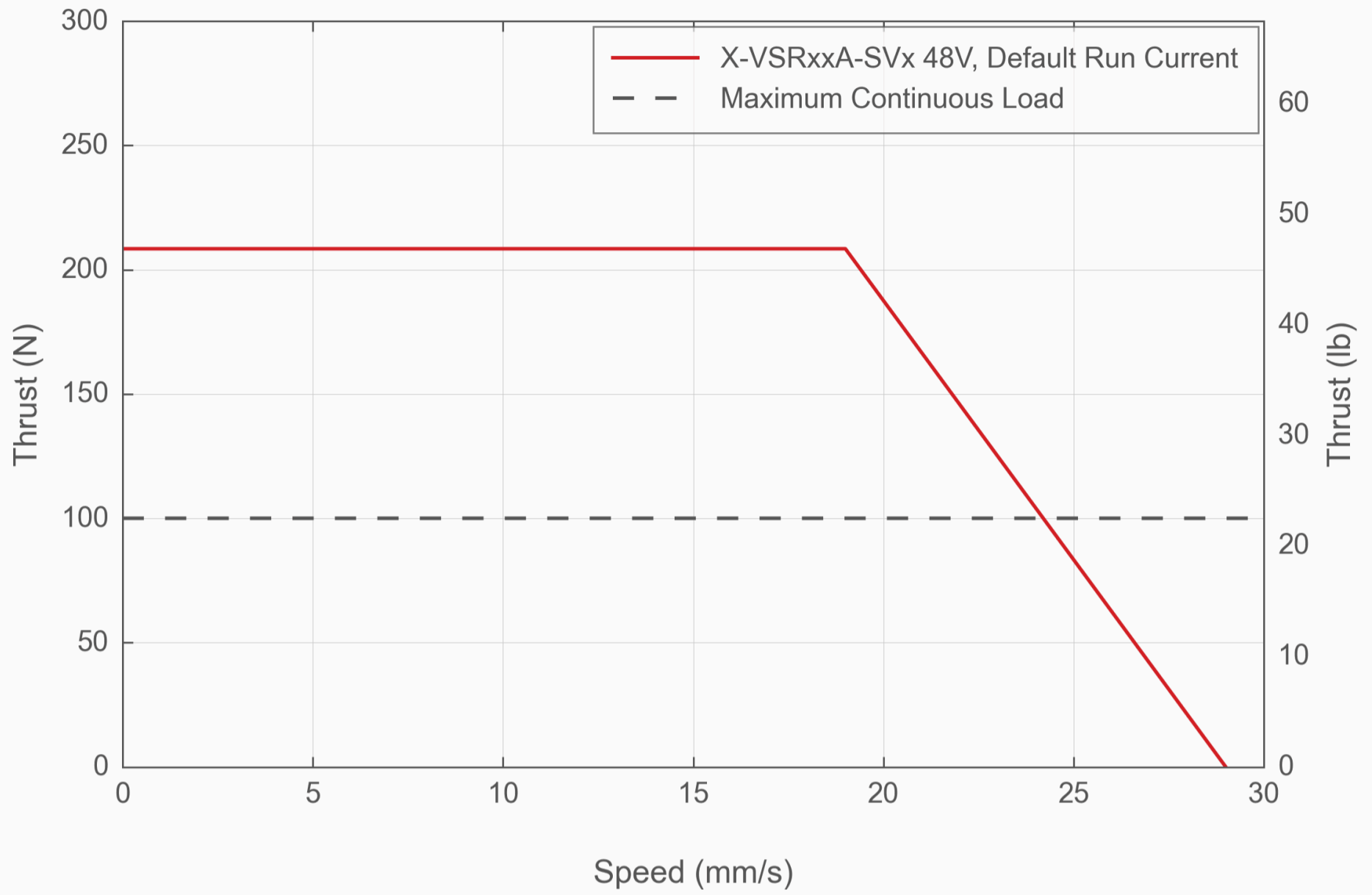

Typical Accuracy

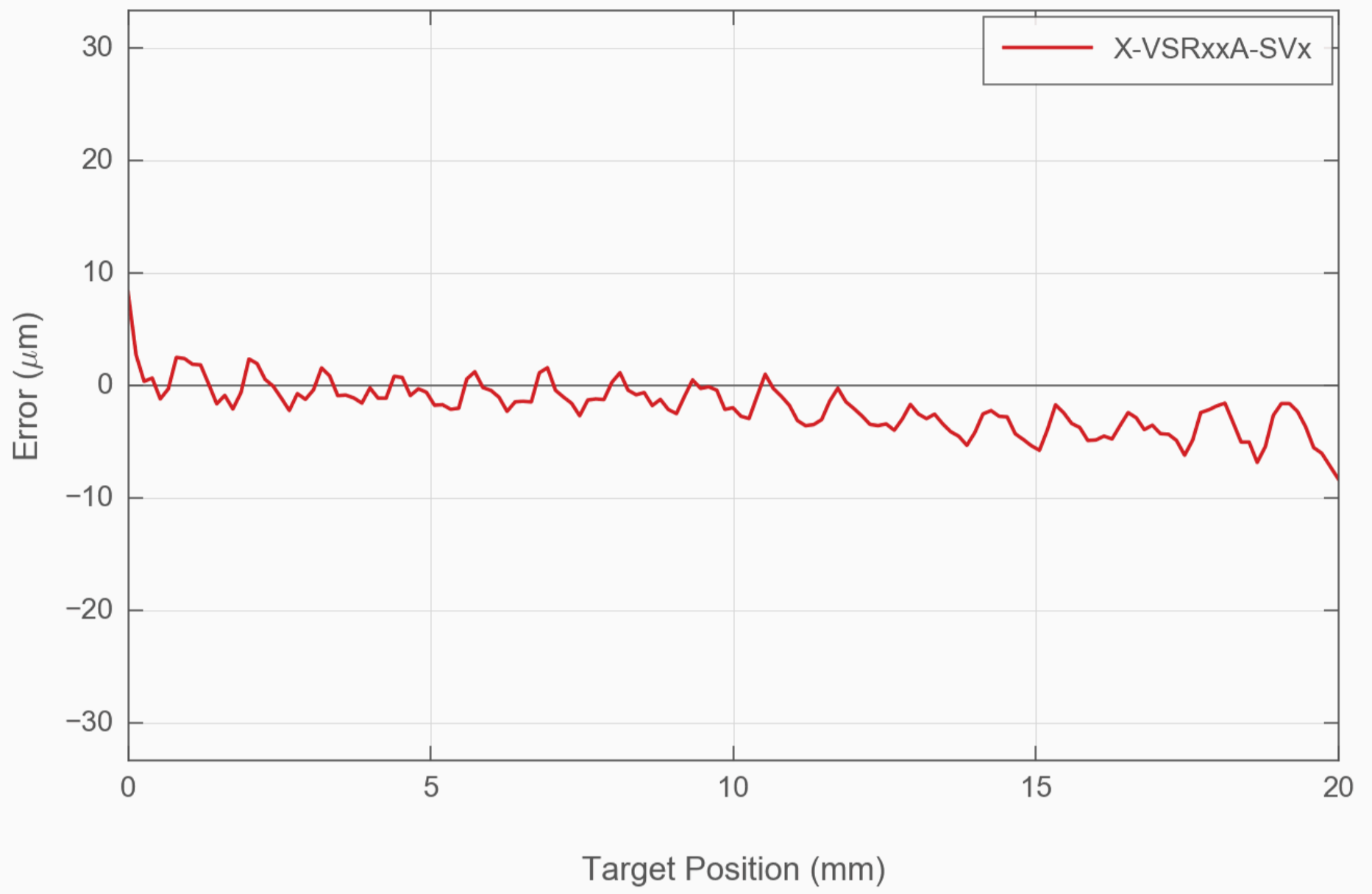

Recommended Duty Cycle

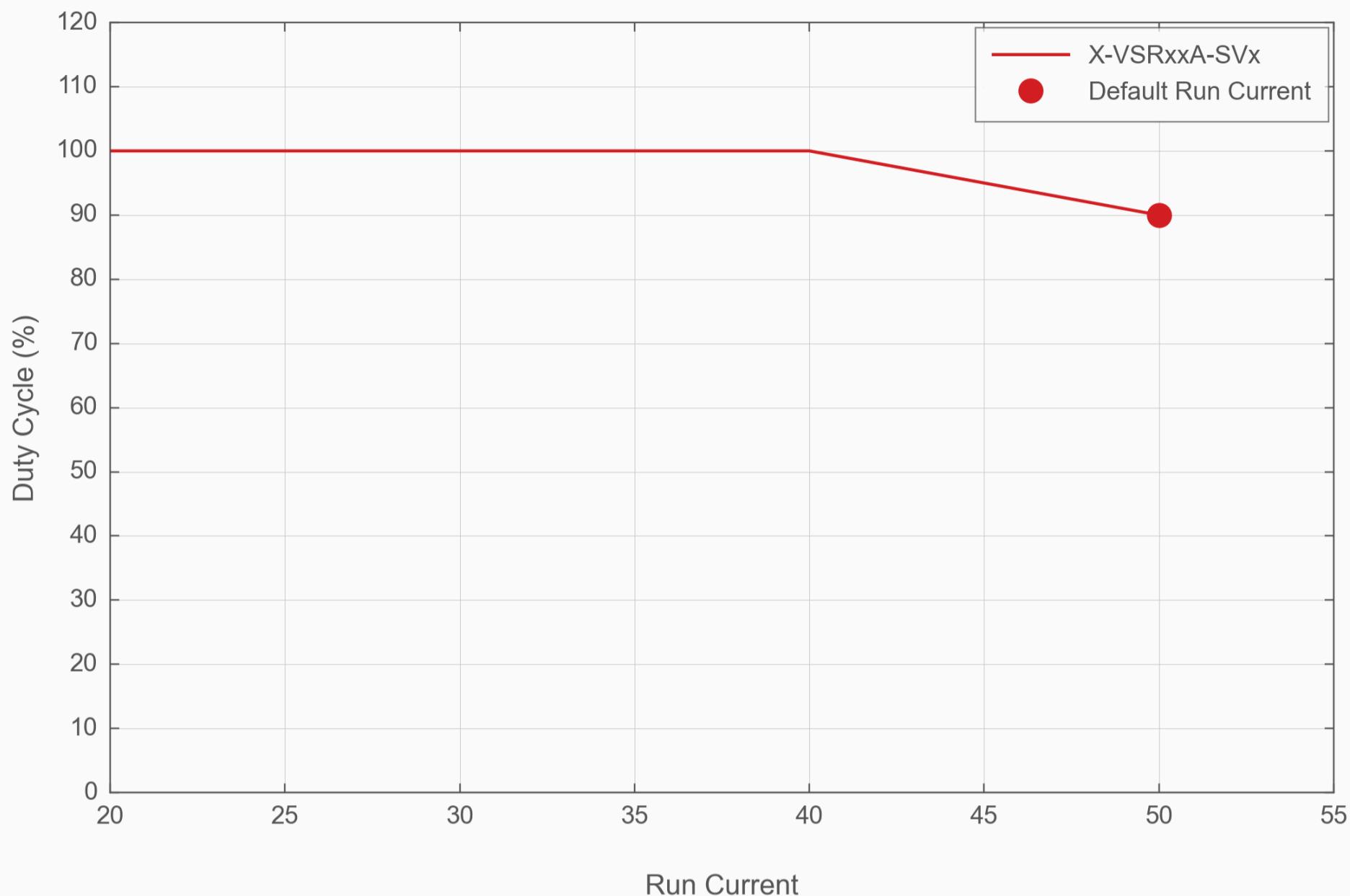

Product Change Notices

Click [here](#) to view the current product change notices and subscribe to future change notifications.

This product uses the FreeRTOS kernel. FreeRTOS is © 2025 Amazon.com, Inc. or its affiliates and is governed by the following license:

All rights reserved.

Permission is hereby granted, free of charge, to any person obtaining a copy of this software and associated documentation files (the "Software"), to deal in the Software without restriction, including without limitation the rights to use, copy, modify, merge, publish, distribute, sublicense, and/or sell copies of the Software, and to permit persons to whom the Software is furnished to do so, subject to the following conditions:

The above copyright notice and this permission notice shall be included in all copies or substantial portions of the Software.

THE SOFTWARE IS PROVIDED "AS IS", WITHOUT WARRANTY OF ANY KIND, EXPRESS OR IMPLIED, INCLUDING BUT NOT LIMITED TO THE WARRANTIES OF MERCHANTABILITY, FITNESS FOR A PARTICULAR PURPOSE AND NONINFRINGEMENT.

IN NO EVENT SHALL THE AUTHORS OR COPYRIGHT HOLDERS BE LIABLE FOR ANY CLAIM, DAMAGES OR OTHER LIABILITY, WHETHER IN AN ACTION OF CONTRACT, TORT OR OTHERWISE, ARISING FROM, OUT OF OR IN CONNECTION WITH THE SOFTWARE OR THE USE OR OTHER DEALINGS IN THE SOFTWARE.

This product uses the LZ4 compression library. LZ4 is © 2011–2016 Yann Collet and is governed by the following license:

All rights reserved.

Redistribution and use in source and binary forms, with or without modification, are permitted provided that the following conditions are met:

- Redistributions of source code must retain the above copyright notice, this list of conditions and the following disclaimer.
- Redistributions in binary form must reproduce the above copyright notice, this list of conditions and the following disclaimer in the documentation and/or other materials provided with the distribution.

THIS SOFTWARE IS PROVIDED BY THE COPYRIGHT HOLDERS AND CONTRIBUTORS "AS IS" AND ANY EXPRESS OR IMPLIED WARRANTIES, INCLUDING, BUT NOT LIMITED TO, THE IMPLIED WARRANTIES OF MERCHANTABILITY AND FITNESS FOR A PARTICULAR PURPOSE ARE DISCLAIMED. IN NO EVENT SHALL THE COPYRIGHT HOLDER OR CONTRIBUTORS BE LIABLE FOR ANY DIRECT, INDIRECT, INCIDENTAL, SPECIAL, EXEMPLARY, OR CONSEQUENTIAL DAMAGES

(INCLUDING, BUT NOT LIMITED TO, PROCUREMENT OF SUBSTITUTE GOODS OR SERVICES; LOSS OF USE, DATA, OR PROFITS; OR BUSINESS INTERRUPTION) HOWEVER CAUSED AND ON ANY THEORY OF LIABILITY, WHETHER IN CONTRACT, STRICT LIABILITY, OR TORT (INCLUDING NEGLIGENCE OR OTHERWISE) ARISING IN ANY WAY OUT OF THE USE OF THIS SOFTWARE, EVEN IF ADVISED OF THE POSSIBILITY OF SUCH DAMAGE.